

# Super Models

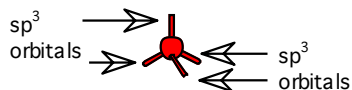
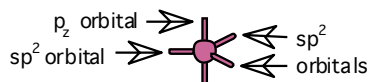
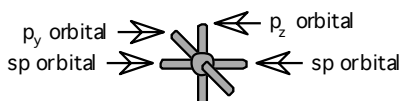

## GENERAL CHEMISTRY

### Molecular Model Kit

© Copyright 2015

Ryler Enterprises, Inc.

Recommended for ages 10-adult

**⚠ Caution:** Atom centers and vinyl tubing are a choking hazard. Do not eat or chew model parts.

#### Kit Contents:

- 12 tetrahedral carbon atom centers
- 12 trigonal planar carbon atom centers
- 20 monovalent hydrogen atom centers
- 6 bent oxygen atom centers
- 3 tetrahedral oxygen atom centers
- 8 tetrahedral sulfur atom centers
- 3 tetrahedral nitrogen atom centers
- 6 tetrahedral halogen atom centers
- 6 green chlorine atom centers
- 3 light green fluorine atom centers
- 3 dark green iodine atom centers
- 4 trigonal bipyramidal atom centers
- 2 octahedral atom centers
- 50 clear, 1.25" tubes (single bonds)
- 2 clear, .87" tubes (sigma bonds)
- 12 clear, 4 cm tubes (double, triple bonds)
- 4 white, 2" tubes (pi bonds)

Ryler Enterprises, Inc.

5701 1st Street

Lubbock, TX 79416

Phone: 806-438-6865

Email: [etishler@rylerenterprises.com](mailto:etishler@rylerenterprises.com)

Website: [www.rylerenterprises.com](http://www.rylerenterprises.com)

## PREFACE

### **For the Classroom Teacher**

We at Ryler Enterprises are confident in your knowledge of the information covered in the beginning pages of this lab manual. In the General Information section, we have shared some concepts and illustrations that we have used in teaching chemistry. You may wish to reprint these to use as supplementary materials to give to your classes.

You are welcome to use the contents of this instruction manual, including the Assessment, for personal use only. Any and all of the material in this PDF is the sole property of Ryler Enterprises, Inc. Permission to reprint any or all of the contents of this manual for resale must be submitted to Ryler Enterprises, Inc.

### **For the Homeschool/Independent Learner**

In your quest to learn general chemistry without the benefit of a chemistry teacher, this kit will provide you with a few of the basic concepts of the topic such as: atomic structure; types of chemical bonds; drawing accurate diagrams of molecules and resonance structures.

You will also be able to visualize molecules and ions in three dimensions as you build the models suggested in the la section. In addition, as your knowledge of chemistry increases, you will be able to make many more models with this kit.

## Table of Contents

### General Information

1. Atomic Structure	1
1.1 An Atomic Structure Analogy	1-3
1.2 Atomic Structure–General Description	3
1.3 The Ground State	3-4
1.4 Orbitals	5-6
2. Preparing Atoms for Covalent Bonding	6
2.1 Electron Promotion	6-7
2.2 Orbital Hybridization	7-12
3. Bond Formation between Atoms	12
3.1 Valence Electrons	12
3.2 Types of Bonds	13
3.2.1 Ionic Bonding	13
3.2.2 Covalent Bonding	13-14
3.3 Sigma ( $\sigma$ ) and Pi ( $\pi$ ) Covalent Bonds	15-16
3.3.1 Modeling $\sigma$ and $\pi$ bonds	16-17
4. Drawing Lewis Structures	17-18
5. Oxidation State vs Formal Charge	18-21
6. Resonance	22

### Lab Procedures

1. PART I: Inorganic molecules and ions	23
2. PART II: Constructing Models of Organic Substances	24
2.1 Alkanes	24
2.2 Alkenes	24
2.3 Alkynes	24
2.4 Aromatic Organic Compounds	25
2.5 Organic Compounds with Oxygen	25
3. PART III Constructing models of biochemical substances	25-26

# GENERAL INFORMATION

## 1. Atomic Structure

### 1.1 An Atomic Structure Analogy.

#### THE ATOMIC CONVENTION CENTER

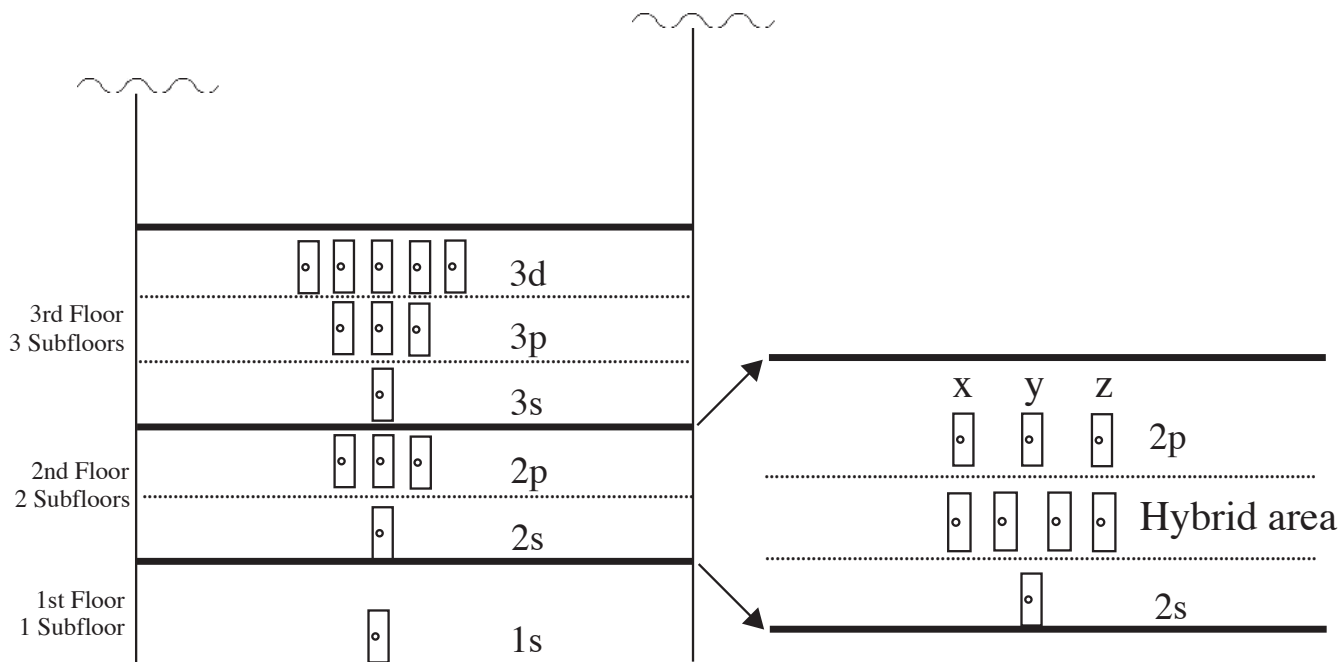

Fig. 1 The atomic convention center hotel.

Before we see how atoms are constructed let's follow the architect and managers as they plan an imaginary hotel for atoms who will be attending a convention. See the above diagram (Fig. 1).

The architect's plans call for building floors, subfloors, and even sub-subfloors which will be called hybrid areas. Since the plans get very complicated above the second floor, we won't consider any floor in detail above floor number two.

Look at the number of subfloors to be included in each floor. The first floor is its own subfloor. Then each floor will have the number of subfloors which correspond to the floor number: e.g. floor #2 has 2 subfloors; floor #3 has 3 subfloors, and so on.

Now, there are only a certain number of rooms planned for each sublevel. The first subfloor of every floor will have one room. The second subfloor, if it exists, will have three rooms, the third subfloor, if it exists, will have 5 rooms. So the sequence is 1, 3, 5, 7, and so on.

The architect has further divided floors into sub-subfloors that he calls "hybrid areas." These areas will have rooms, but they might not be occupied. Their occupancy is somewhat flexible.

The managers step in at this point and set up some rules for running the hotel. They see a problem in giving the rooms identification numbers, so they decide to call the subfloor of each floor “s,” If more subfloors are present on each floor, their designations will be “p,” “d,” and “f.” If more levels are needed, they will follow alphabetically, starting with “g.”

So, the room on the first floor is “1s.”

The bottom subfloor on floor 2 is “2s,” and the room number is “2s,” (since there is only one room). The second subfloor of floor 2 is “2p.” With naming the three rooms on 2p presenting a problem, they are called “2p<sub>x</sub>,” “2p<sub>y</sub>,” and “2p<sub>z</sub>,” in order to avoid confusion.

The third floor “3s” and “3p” subfloors use the same type of naming system as “2s” and “2p” did. The five rooms on “3d” have complex names that we will not go into at this time.

The managers’ names are Dr. Aufbau, Dr. Pauli, and Dr. Hund. Dr. Aufbau suggests that the rooms be assigned to clients as follows. The lowest-subfloor room should be filled first, then the next lowest subfloor room(s), and so on. Here is a short version of the assignment chart that Dr. Aufbau created (Fig. 2).

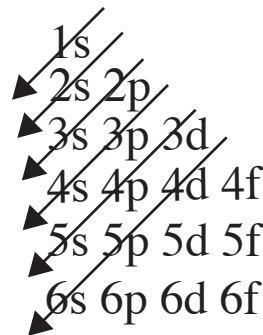

Fig. 2 The sequence for assigning rooms.

Follow the back of each arrow toward the point, and then go to the next arrow to follow the order. For example, 1s, 2s, 2p, 3s, 3p, 4s.... Evidently Dr. Aufbau thinks it takes less energy to get to 4s than to get to 3d. Well, he is the manager, and he knows more than we do.

Dr. Pauli is next to set up the hotel rules. He wants to limit room occupancy to no more than two individuals. That means two people in 1s, two people in 2s, two people in each of the three rooms on the 2p level, for a total of six for that subfloor.

Dr. Hund steps up now and says he would like each room in any multi-room subfloor to have one occupant before the next occupant goes into a room. Here’s what he means. If the “2s” room has two people and four more customers come along, they must go into rooms in “2p.” However, one must go into “2p<sub>x</sub>,” one into “2p<sub>y</sub>,” and one into “2p<sub>z</sub>.” Then the fourth person can go into, say “2p<sub>x</sub>,” to make that room have two occupants, which is the maximum allowed in any room.

Dr. Hund adds that he has done research, and he has found that it is more economical and energy saving if each subfloor is either completely filled or completely half filled. He means, for instance, that the subfloor, “2p,” should have six or three occupants for the best economy. It would also be best for 3d to have either five or 10 occupants.

## 1.2 Atomic Structure-General Description.

Atoms have structures very similar to the atomic hotel, and the rules of Drs. Aufbau, Pauli, and Hund apply to atoms as well.

Atoms are composed of two main components; the nucleus and the surrounding spaces, usually called energy levels, where we find electrons. Try to relate this discussion of atomic-electronic structure to the preceding analogy of the atomic hotel.

We will limit our investigation into atomic structure to the electrons. The energy levels (called shells, and numbered 1, 2, 3...) are divided into areas known as subshells. The first energy level has one subshell, the second has two, the third has three, and so on. These subshells have letter designations. The lowest subshell in each shell is called “s,” then come “p,” “d,” and “f.” If more levels are needed, just follow alphabetically, starting with “g.” Each subshell has spaces called orbitals. Each orbital is able to hold no more than two electrons. This is Pauli’s exclusion principle. We use the Aufbau principle to add electrons to atoms. Aufbau is German for “a building up.” To build an atom’s electron structure, start with the lowest energy orbital, and when that is full, go to the next lowest level to add more electrons if needed. Use the same scheme as in Fig. 2, above.

## 1.3 The Ground State.

Fig. 3 shows the energy (E) levels and orbitals that would be open to accommodate up to 28 electrons in an atom. The hybrid areas have been omitted, and circles for orbitals replace doors in the hotel analogy.

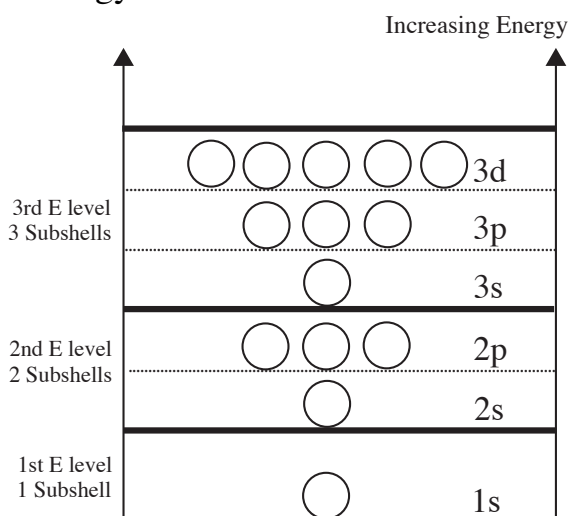

Fig. 3 The first three energy levels, sublevels, and orbitals.

An atom which has not gained or lost energy is said to be in a ground state. Let's look at some energy diagrams for atoms in their ground states, but first keep this in mind: electrons have a property called *spin*, indicated with a half arrow. The energies of the two different spins are different so the electrons are able to share one orbital space. See Fig. 4. This is important because, according to the Pauli exclusion principle, no two electrons in an atom can have the same amount of energy.

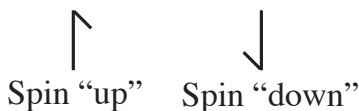

Fig. 4 Arrows representing electrons with different spins.

Below are electron-energy level diagrams can be found for the first 10 elements, hydrogen through neon. One electron will be added to each atom, in sequence, according to the Aufbau, Hund, and Pauli rules. See Fig. 5.

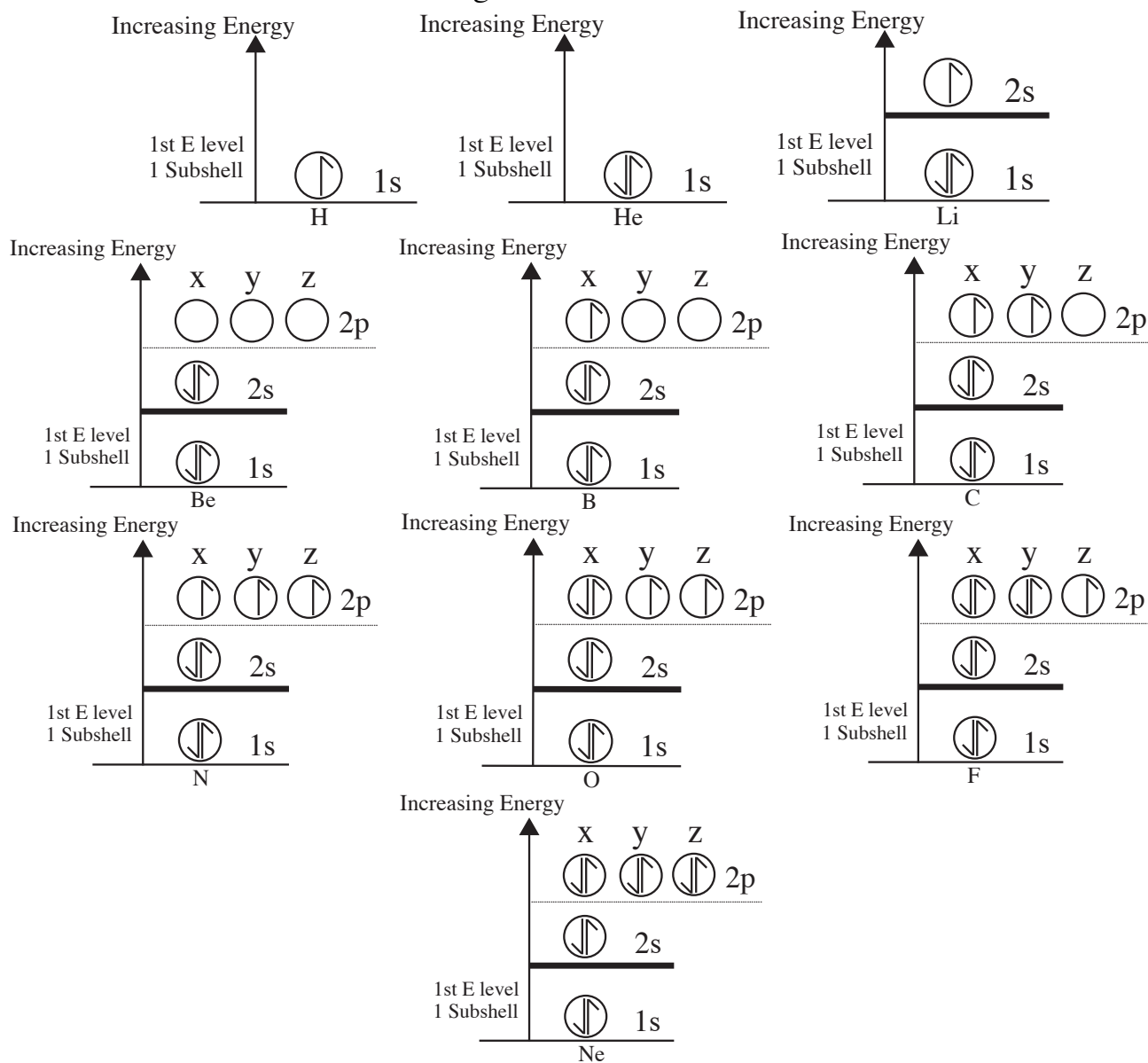

Fig. 5 Energy level diagrams for atoms hydrogen through neon.

## 1.4 Orbitals

Chemists have discovered the shape of each type of orbital. It is important to keep in mind that the solid, three-dimensional illustrations are for ease of learning the generalized shapes of the orbitals. Each orbital is more accurately represented by a mathematical equation that produces an electron “cloud.” The “cloud” is similar to an instantaneous photo taken of the possible locations of an electron within the orbital. Fig. 6 shows the possible locations for an *s* orbital, *p* orbital, and a *d* orbital electron, from left to right in the top row. The smoothed out versions, in the same order from left to right, are across the bottom row.

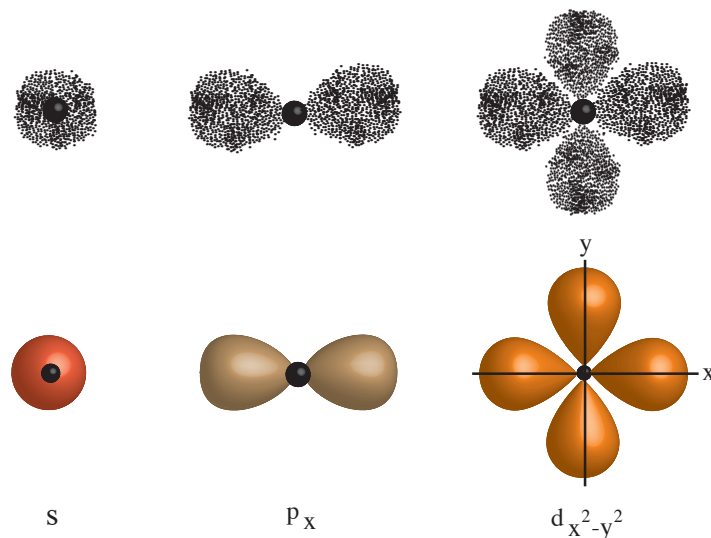

Fig. 6 Three types of atomic orbitals.

At any energy level, an *s* orbital is shaped like a sphere with the nucleus in the center. No matter where it is found a *p* orbital, has two parts, or lobes, each shaped like teardrop. Every *p* subshell has three orbitals, each one being aligned along an axis of three-dimensional space (i.e. X, Y, or Z). A *d* orbital has four lobes.

Fig. 7 illustrates an *s* orbital (red), and the three *p* orbitals (pale blue, brown, and green), together and then separately. The black dot in the middle is the nucleus.

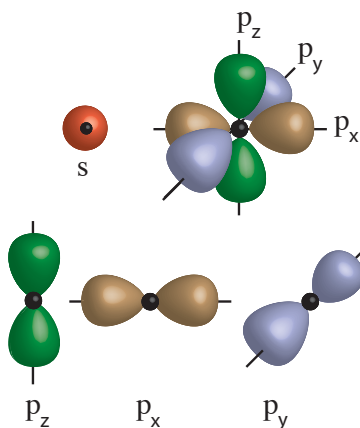

Fig. 7 An *s* orbital and three *p* orbitals together and then separately.



Fig. 8 shows how the five  $d$  orbitals are, separately, arranged in space. How their shapes were determined is not as important as how they are aligned relative to the axes of three-dimensional space as well as the names of the orbitals.

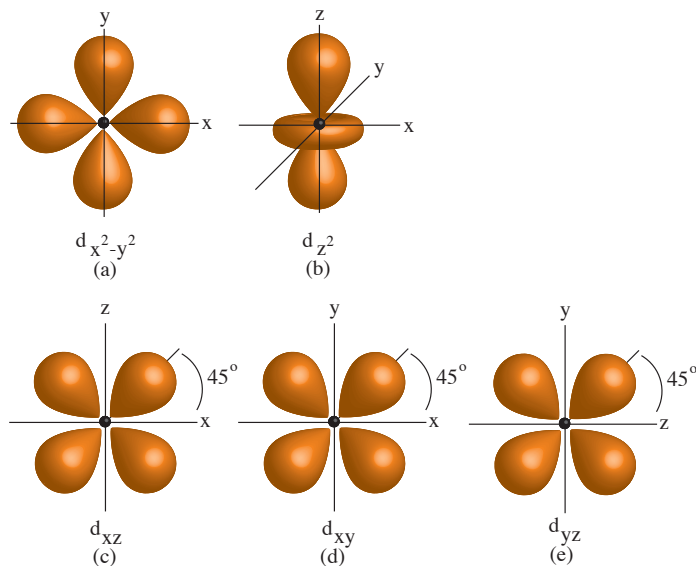

Fig. 8 The five  $d$  orbitals.

If you are interested in remembering the names and orientations of the  $d$  orbitals, the task is not that difficult. The  $d_{z^2}$  has its teardrop lobes on the  $z$  axis and its ring on the  $xy$  axis. The  $d_{x^2-y^2}$  orbital lobes are on the  $xy$  axes. The remaining orbitals are offset from the three axes by  $45^\circ$ . It is much simpler to visualize the orbitals by considering each pair of axes independently.  $d_{xy}$  is only between the  $xy$  axes, the  $d_{xz}$  is between the  $xz$  axes, and  $d_{yz}$  is between the  $yz$  axes.

Once again, the black dots represent the nucleus. Each orbital, except  $d_{z^2}$ , has four lobes. That is, the four lobes of (a), (c), (d), or (e) make up one orbital. (b), on the other hand, has two lobes, one is made of the two teardrop shapes on the  $z$  axis, and the other has a donut shape on the  $x$  and  $y$  axes.

## 2. Preparing Atoms for Covalent Bonding.

### 2.1 Electron Promotion-a change in the location of electrons.

We will use a carbon atom as an example of electron promotion, while forming four bonds, a carbon atom will promote (give extra energy to) a  $2s$  electron and move it to the empty  $2p_z$  orbital. See Fig.9.

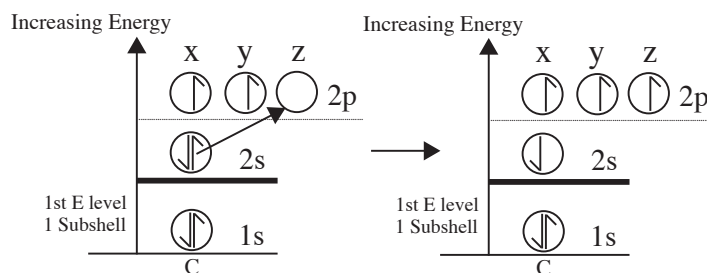

Fig. 9 A carbon atom  $2s$  electron being promoted.

With one electron in each of its four valence (outer) orbitals now, the carbon atom is ready to bond with four other atoms.

A second alteration of orbitals takes place as an atom of carbon forms bonds with four other atoms. Studies have shown that the angles between the four bonds are the same;  $109.5^\circ$ . But the angles between the  $p$  orbitals is supposed to be  $90^\circ$  and the  $s$  orbital can form a bond in any direction. In order to account for this apparent discrepancy, we will introduce the concept of orbital hybridization.

## 2.2 Orbital Hybridization.

Remember the Atomic Convention Center Hotel? If you don't, take a look back at Fig. 1. We are now going to see what happens to that special floor-splitting called the "Hybrid area." What we see in Fig.10 is a mixing, or blending of an  $s$  orbital and three  $p$  orbitals. The result of the mixing the four orbitals is four new orbitals with properties of both parent types of orbitals. Each orbital is 25%  $s$  and 75%  $p$ . That is, the new orbitals are hybrids, each one with a name that indicates the parent orbital source. See Fig. 10.

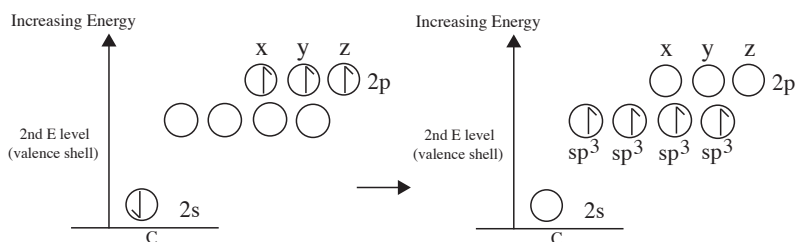

Fig. 10 On the left, before hybridization, and on the right, after.

The name of each of the new orbitals is  $2sp^3$ . The number 2 tells us that the orbitals and electrons are in the second energy level. The  $s$  and  $p^3$  indicate that there are a total of four orbitals composed of a mix of one  $s$  and three  $p$  orbitals. When atomic orbitals combine to form hybrids, the number of combining orbitals will always equal the number of hybrids.

Each new orbital also has a new energy level, shape, and direction in which it is oriented. Fig. 11 is a diagram of the combining of one  $2s$  and three  $2p$  orbitals of carbon to produce four  $sp^3$  orbitals. Each one has a large and a smaller lobe, but the smaller lobes have been left out for clarity.

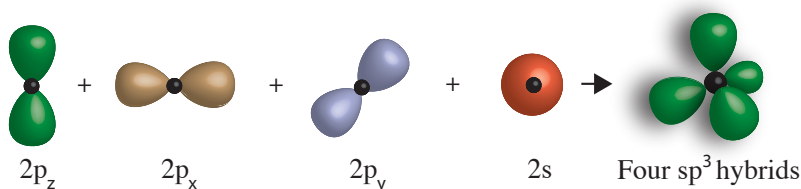

Fig. 11 The formation four  $sp^3$  hybrids.

Fig. 12 shows the hybrids, including the small lobe, separated from each other. The black dots are nuclei.

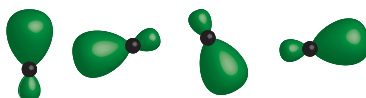

Fig. 12 Four separated  $sp^3$  hybrids.

This General Chemistry Kit contains atoms with four pegs, each peg representing an  $sp^3$  atomic orbital. These atoms have a tetrahedral shape. Locate and observe one carbon atom (black with four pegs). See Fig. 13.

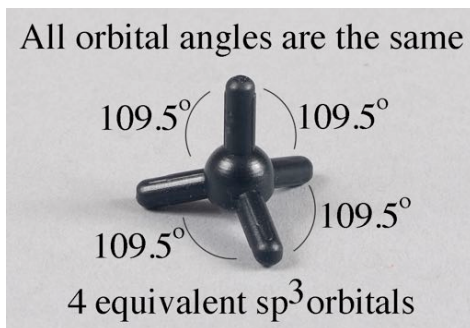

Fig. 13 A tetrahedral placement of hybrid orbitals.

Carbon atoms (and atoms of other elements as well) can undergo two more types of hybridizations;  $sp^2$  and  $sp$ . Below, in Fig. 14, the result of combining one  $2s$  electron with two  $2p$  electrons to form three new hybrids is shown. These hybrids are called  $sp^2$ . Notice that one of the  $p$  orbital electrons was left behind in its original orbital. That electron can be used to make a bond, as we shall see when we look at a molecule of ethylene.

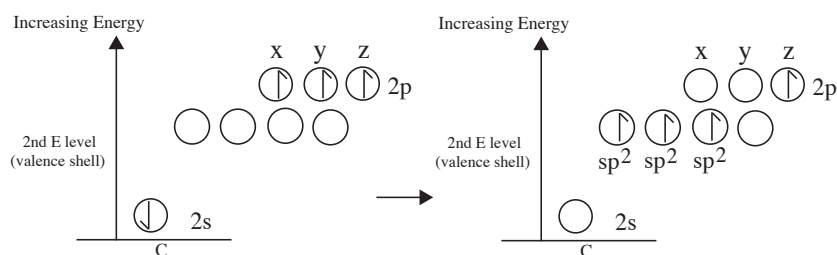

Fig. 14 An atom of carbon forming three  $sp^2$  orbitals.

Fig. 15 is a diagram of the combining of one  $2s$  and two  $2p$  orbitals of a carbon atom to form three  $sp^2$  orbitals. Each orbital has a large and a smaller lobe, but the smaller lobes have been left out for better clarity. Fig. 16 shows the hybrids, including the small lobes, separated from each other. The black dots are nuclei.

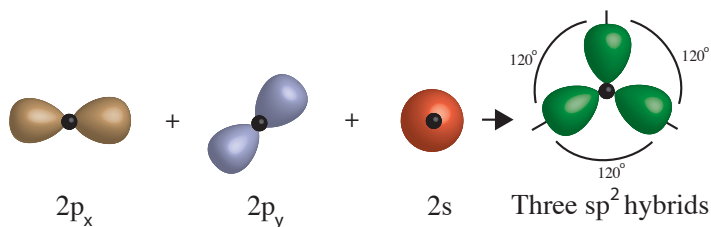

Fig. 15 Two  $p$  orbitals join with an  $s$  orbital to form three  $sp^2$  orbitals.

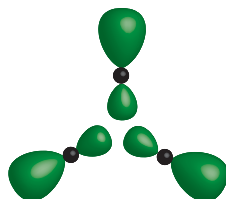

Fig. 16 Separated hybrid  $sp^2$  orbitals.

Look for a purple atom with five pegs that can be used to demonstrate  $sp^2$  orbitals of a carbon atom along with the two unhybridized lobes of one  $p$  orbital. The angle between each of the three  $sp^2$  orbitals is  $120^\circ$ . The angle between the  $sp^2$  orbitals and the single-unhybridized  $p$  orbital (with two lobes) is  $180^\circ$  (Fig. 17). The spatial arrangement of these orbitals is known as trigonal bipyramidal.

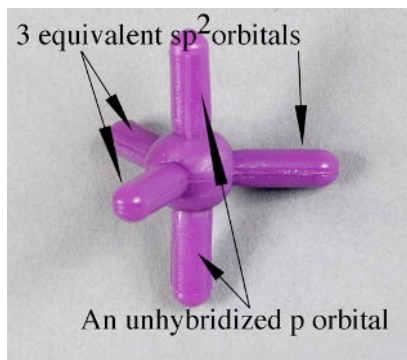

Fig. 17 An atom of carbon with  $sp^2$  hybridization.

Another possible hybridization in carbon atoms is  $sp$ . Fig. 18 illustrates how these hybrids are formed. Notice that two of the  $p$  orbitals have not combined.

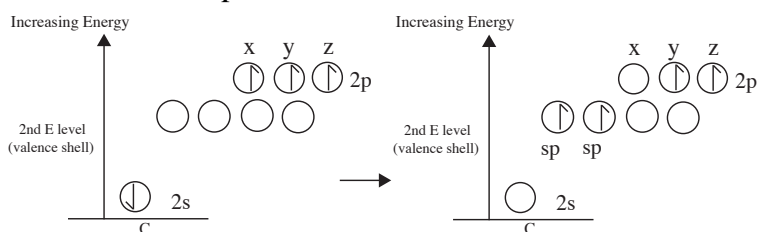

Fig. 18 A carbon atom forming two  $sp$  orbitals.

Fig. 19 is a diagram of the combining of one  $2s$  and one  $2p$  orbital of a carbon atom to produce two  $sp$  orbitals. Each hybrid has a large and a smaller lobe, but the smaller lobes have been left out. Fig. 20 shows two separated  $sp$  hybrids, including their small lobes.

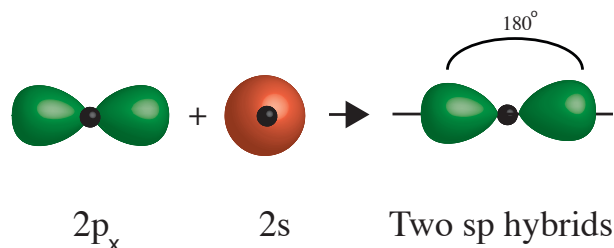

Fig. 19 Blending one  $s$  and one  $p$  orbital.

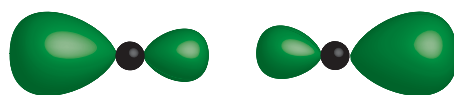

Fig. 20 Two  $sp$  orbitals.

Find a silver atom with six pegs, two of which can be used to model two  $sp$  hybrid orbitals. Two pegs opposite each other will be the two lobes of a  $2p_z$  unhybridized orbital, and the remaining two pegs will be the two lobes of a  $2p_y$  unhybridized orbital of a carbon atom (Fig. 21).

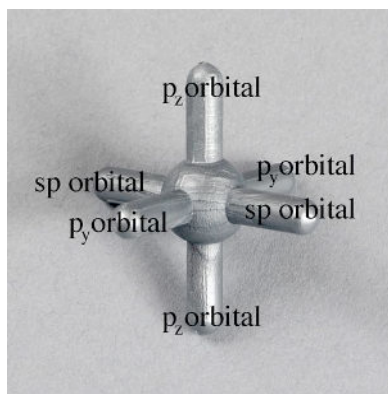

Fig. 21 An atom of carbon with two  $sp$  orbitals and two unhybridized  $p$  orbitals.

Elements in the third row and beyond are able to recruit  $d$ -subshell orbitals for hybridization. For example, phosphorus can promote a  $3s$  electron to an empty  $3d$  orbital (Fig. 22 on the left of the arrow) and then combine a  $3s$ , three  $3p$ , and one  $3d$  orbital. The resulting five  $sp^3d$  hybrid orbitals, on the right of the arrow, each with a single electron can then be used to form a covalent bond, which is a sharing of electrons, to five other atoms. The nature of bonding atoms will be covered later.

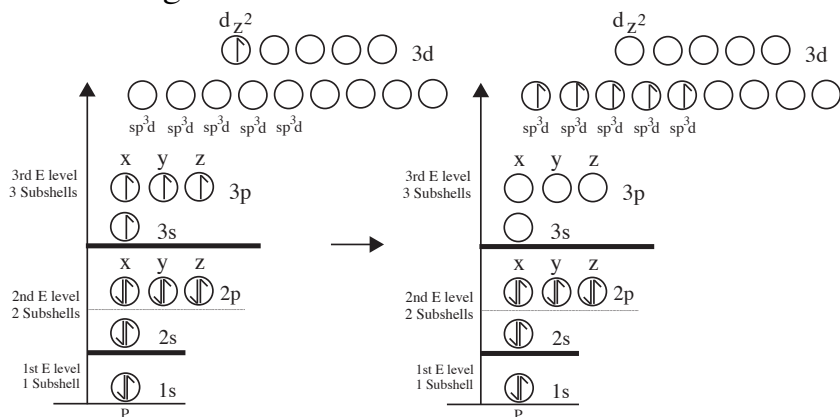

Fig. 22 An atom of phosphorus forming five  $sp^3d$  orbitals.

Fig. 23 is a diagram of the mixing of one  $3s$ , three  $3p$ , and one  $3d_{z^2}$  orbitals of phosphorus to form five  $sp^3d$  orbitals. Once again, each hybrid orbital has a larger and a smaller lobe, the latter being left out for a better view. Fig. 24 shows the  $sp^3d$  hybrids, including the small lobes, separated from each other.

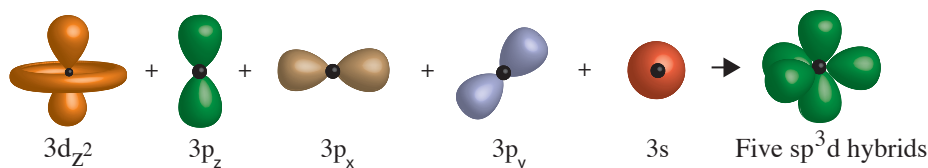

Fig. 23 Five orbitals combine to form five  $sp^3d$  orbitals.

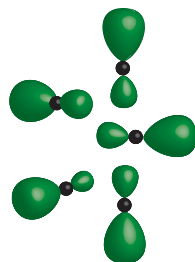

Fig. 24 Five complete and separated  $sp^3d$  orbitals.

The geometry of this hybrid is known as trigonal bipyramidal. In Fig. 25, the purple atom represents phosphorus, and each peg is one of five  $sp^3d$  hybrid orbitals.

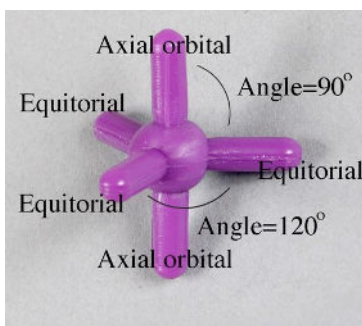

Fig. 25  $sp^3d$  hybridization by a phosphorus atom.

In the final example of hybridization, we will use a sulfur atom promoting two electrons, one from a 3s orbital and one from a 3p orbital, to the 3d level (Fig. 26). After promotion, the sulfur atom will form six hybrid orbitals available for bonding. On the left in Fig. 27, sulfur has promoted the two electrons, and on the right, one 3s orbital, three 3p orbitals, and two 3d orbitals combine to form six  $sp^3d^2$  hybrid orbitals. Fig. 27 shows the shapes of the individual combining orbitals and the final form of the hybrids, without their small lobes.

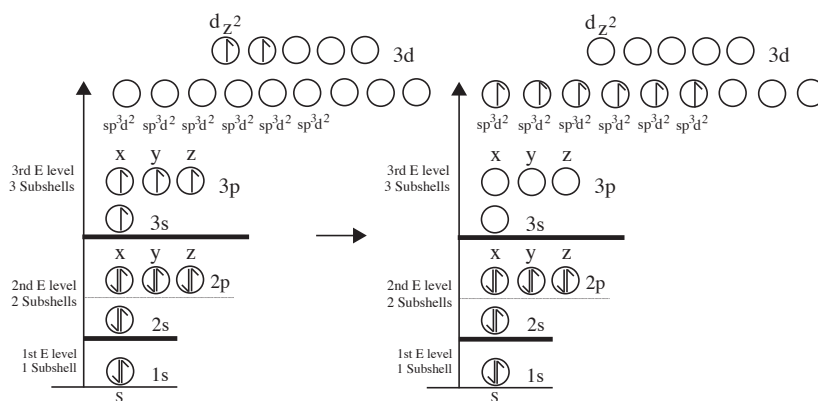

Fig. 26 Forming six  $sp^3d^2$  hybrid orbitals.

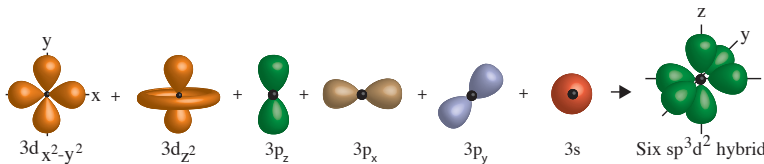

Fig. 27 Combining six orbitals to form six  $sp^3d^2$  orbitals.

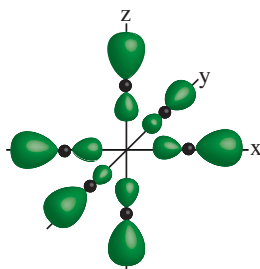

Fig. 28  $sp^3d^2$  orbitals with all the lobes present.

The angle between any two orbitals is  $90^\circ$ . The shape of an atom of sulfur with this hybridization is known as octahedral. Use a silver, six-peg atom again. This time, each peg will represent an  $sp^3d^2$  hybridized orbital. See Fig 29.

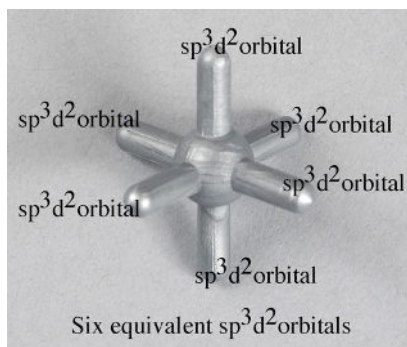

Fig. 29 An  $sp^3d^2$  hybridized sulfur atom.

### 3. Bond Formation between Atoms

In a beginning chemistry class, it is common for students to learn about why and how atoms join, that is, bond together to make molecules, or to make crystals.

The “why” of bonding is that bonded atoms enter into a lower energy state. Energy is always released when atoms combine. When energy is released, any system (some part of the universe) becomes more stable, which means it will resist change.

The “how” of bonding is by atoms partly intermingling their orbitals followed either by losing or gaining electrons, or by sharing one or more pairs of electrons.

#### 3.1 Valence Electrons

Valence electrons are used to form bonds. Valence electrons are usually in the outermost (highest) energy level (abbreviated  $n$ ) orbitals of an atom. This is the case for the representative elements, that is, the elements in groups 1, 2, and 13 through 18 of the periodic table. However, some valence electrons are found in a lower energy level ( $n-1$ ). Transition elements, metals in groups 3 through 12, regularly use these electrons, along with  $n$  electrons, for bonding.

## 3.2 Types of Bonds

Three major types of strong bonds form: metallic, ionic, and covalent. In these instructions, only the last two are described.

### 3.2.1 Ionic Bonding

When an atom with a weak attraction for its valence electron(s) approaches an atom with a strong attraction for valence electron(s) collides, an electron from the weaker atom can be transferred to the stronger atom. The result is the formation of a positive and a negative ion. See Fig. 30.

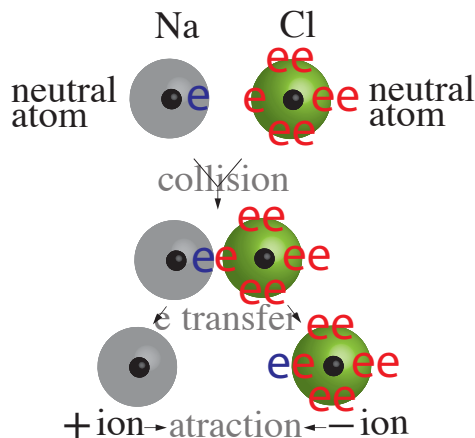

Fig. 30 Formation of a pair of oppositely charged ions.

An ion is an atom or group of atoms that has lost or gained one or more electrons.

An atom gaining electrons becomes an ion with a negative charge, and is then known as an anion. An atom losing electrons becomes an ion with a positive charge called a cation. The electrons that are exchanged are valence electrons.

As a cation (+) approaches an anion (-), a strong electrostatic attraction bonds the ions together. Because the charge on an ion is distributed around the atom in a spherical shape, an ionic bond is omnidirectional. That is, the bond may form in any direction.

### 3.2.2 Covalent Bonding

Covalent bonds form when atomic orbitals from two different atoms overlap allowing a sharing of one or more pairs of electrons.

Here is an example of how bonding between hydrogen and carbon might take place. Remember in Fig. 5 we saw energy diagrams for the electrons of several elements including hydrogen and carbon? They appear again in Fig. 31 side by side.

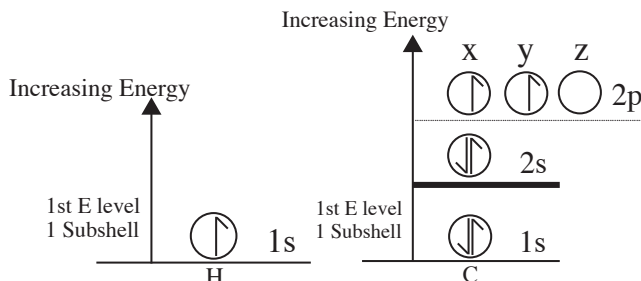

Fig. 31 Energy diagrams of hydrogen and carbon.



Hydrogen would be much more stable if it had two electrons in its only orbital, and carbon would be more stable if it had orbitals with two electrons each as well. On the left of the arrow in Fig. 32, you can see two hydrogen atoms (yellow), each with a single electron, approaching the  $2p_x$  and  $2p_z$  orbitals of a carbon atom. On the right of the arrow, the overlap of the two hydrogen  $1s$  and carbon two  $2p$  orbitals has occurred. Each hydrogen  $1s$  orbital has two electrons, and the carbon  $2p_x$  and  $2p_y$  orbitals also have two electrons each. The three atoms are now more stable (Hund's rule).

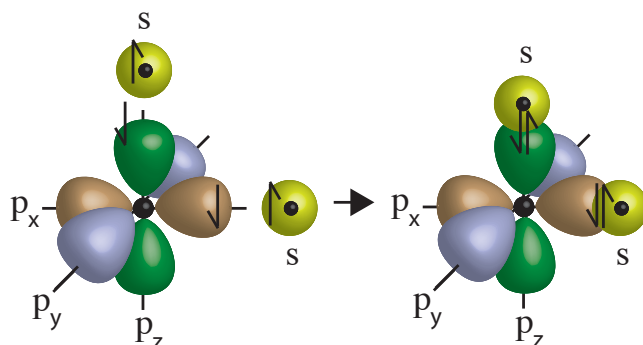

Fig. 32 A carbon atom sharing electrons with two atoms of hydrogen.

There are two problems with this scenario. First, the formula of the new molecule formed this way would be  $\text{CH}_2$ .  $\text{CH}_2$  is so unstable it does not exist. Second, the angle between the  $\text{C}-\text{H}$  bonds would be  $90^\circ$ , and carbon does not form compounds with  $90^\circ$  angles between bonds. A better idea of how atoms bond can be arrived at from a closer investigation of the formation of a molecule produced by bonding one carbon and four hydrogen atoms.

In Fig. 33 we see an  $sp^3$  hybridized carbon atom with a tetrahedral shape along with four hydrogen atoms. The carbon's hybridized orbitals contain one electron each. Each of the hydrogen atoms also have one electron. When a hydrogen orbital overlaps an  $sp^3$  carbon orbital, both orbitals feel the presence of two electrons, lose energy, gain stability, and form a bond.

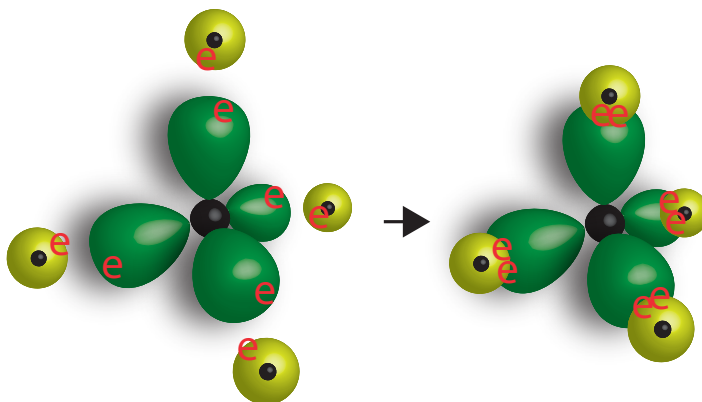

Fig. 33  $sp^3$  carbon orbitals bonding with hydrogen orbitals.

### 3.3 Sigma ( $\sigma$ ) and Pi ( $\pi$ ) Covalent Bonds

When the atomic orbitals of two different atoms overlap so that the electrons they contain can be concentrated between the nuclei of the two atoms, a sigma ( $\sigma$ ) bond results. Fig. 34 shows a  $\sigma$  bond formed by two  $s$  orbitals, on the top left. On the top right, one  $s$  and one  $p$  orbital intermingle to form a  $\sigma$  bond. Then at the bottom of the figure, two  $x$  oriented  $p$  orbitals form the  $\sigma$  bond. The arrows point to the overlapping orbitals where the bonds are the strongest.

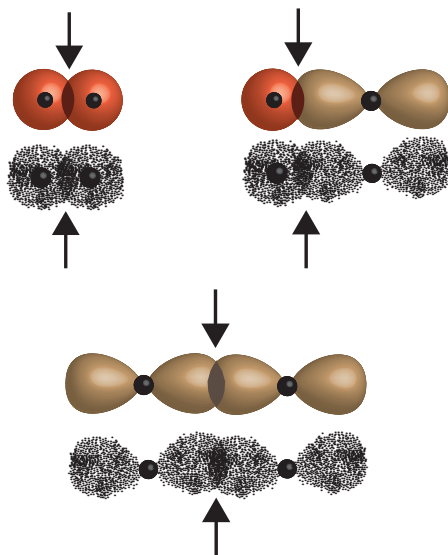

Fig. 34  $\sigma$  bonds as indicated by the arrows.

Hybrid orbitals are also able to participate in  $\sigma$  bonding as long as the bond concentrates the shared pair of electrons between two nuclei, Fig. 35.

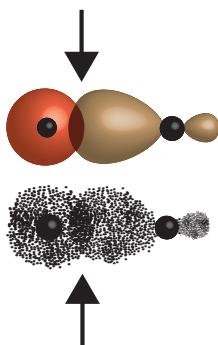

Fig. 35 A  $\sigma$  bond formed by a hybrid orbital and an  $s$  orbital as indicated by the arrows.

A pi ( $\pi$ ) bond is formed by the overlapping of both lobes of an  $x$ ,  $y$  or  $z$  oriented  $p$  orbital with a  $p$  orbital of the same orientation on another atom as you can see in Fig. 36. The arrows labeled  $a$  and  $b$  are pointing to the two parts of one  $\pi$  bond: one is above a line through the nuclei, and one is below. The overlapping of the two  $p_z$  orbitals takes place in two places at the same time.

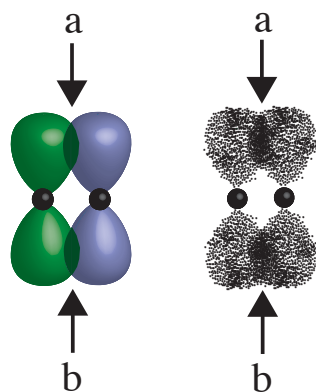

Fig. 36 A  $\pi$  bond shared by  $p_z$  orbitals of two different atoms.

$\pi$  bonds are not as strong as sigma bonds because the bonding does not take place on a line between the nuclei of the bonding atoms. Rather,  $\pi$  bonding occurs either to the left and right or above and below the nuclei.

### 3.3.1 Modeling $\sigma$ and $\pi$ bonds

Using two trigonal bipyramidal atom centers, both  $\sigma$  and  $\pi$  bonding can be demonstrated in a model of ethylene (ethene). The two trigonal bipyramidal atom centers (purple, 5 peg) will represent atoms of carbon with  $sp^2$  hybridization.

Attach two 1.25'' tubes to two of the equatorial pegs of the purple atom center (see Fig. 37). Do the same to the second purple atom center. Next, insert a peg of a white hydrogen atom center into each tube.

These carbon to hydrogen bonds are the  $\sigma$  type. Attach the two carbons to each other with the shortest tube which represents another  $\sigma$  bond.

The pegs in the vertical orientation, one pointing up and the other pointing down, are two lobes of one  $p$  orbital. Using two long, thin-white tubes attach the pegs of one carbon atom to the pegs of the other carbon atom.

Note that both of the long tubes together make up one  $\pi$  bond. Compare your model to Fig. 35.

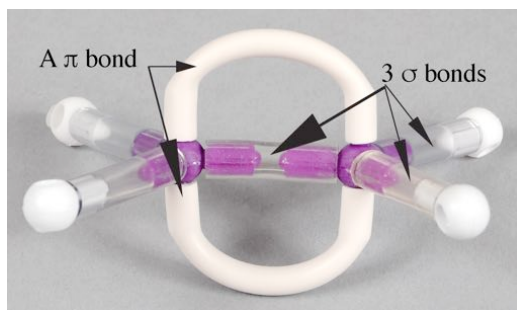

Fig. 37 A model of ethylene with five  $\sigma$  and one  $\pi$  bond.

Try to spin a carbon atom while holding the other carbon in a fixed position. The double bond (composed of one  $\sigma$  and one  $\pi$  bond) should prevent the rotation. Now attempt to spin a hydrogen atom around its  $\sigma$  bond to a carbon atom. You should be successful this time. Sigma bonds allow free rotation.

When bonding atom centers with a single bond, symbolized by a single dash ( – ) or by simply placing two element symbols together, e.g. OH, use a 1.25" piece of tubing. When it becomes necessary to make a double (or triple) bond, use two (or three) of the long, thin clear tubes.

#### 4. Drawing Lewis Structures

##### Step 1.

From the molecular formula of the molecule, write the symbols of the atoms with dashed lines between them. The least electronegative should be used as the central atom. Hydrogen atoms will always be terminal (on an end), since those atoms usually have one bond. The same is true for the halogens, except in some molecules which are composed of halogens exclusively. Fluorine, the most electronegative element will always be terminal. When the chemical formula of a compound is written, very often the order in the formula is the same as the order of the atoms in the Lewis structure.

##### Step 2.

Using a periodic table, find the number of valence electrons of all the participating atoms. The group number in the older "A, B" system will be the number of valence electrons. If you use the new numbering system, subtract ten from group numbers 13 through 18 to get the valence number. Subtract two for each dash put between the atoms (each dash represents a pair of shared electrons). Subtract one for each positive charge if you are dealing with a positively charged ion. Add one for each negative charge if you are drawing the Lewis structure of a negatively charged ion.

##### Step 3.

Next, using the total from Step 2, place the valence electrons, in pairs, around the atoms starting with the most electronegative elements first until each atom has an octet. Be aware that some elements will have less than an octet: H, Be, Be, Al, and sometimes N. Some might have more than eight electrons: elements in the p block beyond row two of the periodic table. If there are left over electrons, put them on the central atom.

##### Step 4.

If some atoms have less than an octet, move lone pairs into a bond from another atom to form an octet.

### Step 5.

Check the structure for formal charges. If the structure is a neutral molecule, formal charges on each atom will be zero, but if some atoms have charges, they should be as low as possible, and the charge should fit with the electronegativity of the atom. That is, usually negative charges will reside on highly electronegative atoms.

### Step 6.

Make resonance hybrids, if needed.

### Example:

1. Draw the Lewis structure for HCN (hydrocyanic acid).

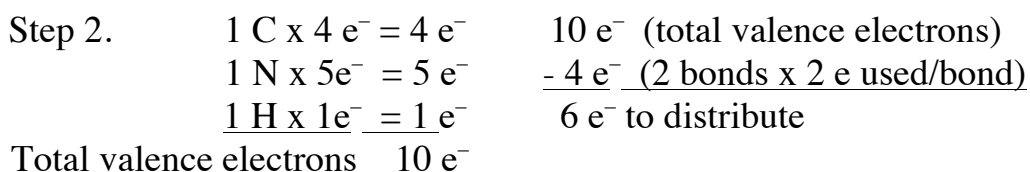

Step 3.

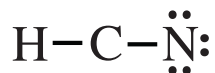

Step 4. Hydrogen with two electrons has its required duet. Nitrogen has an octet. Carbon lacks an octet, so we move lone pairs from nitrogen into the bond with nitrogen. Nitrogen doesn't lose electrons, but carbon will gain them.



Both carbon and nitrogen now have an octet.

Step 5. Determine the formal charge on each atom. See the following discussion.

## 5. Oxidation State vs Formal Charge.

The **oxidation state** of an atom is an indication of how many electrons it “owns” within a molecule. When two atoms bond, the one with the highest electronegativity is assumed to possess its own nonbonding electrons and the bonding electrons as well. This approach tends to view the atoms as ions even in covalent compounds.

For HCN atoms, the electronegativity trend is:  $\text{H} < \text{C} < \text{N}$ .

Oxidation State = Valence Electrons – Bonding Electrons – Lone Pair Electrons. Boxes or circles drawn around the elements and the electrons they “own” help to visualize assignment and counting of electrons.



For H,  $1 - 0 = +1$ ; for C,  $4 - 2 = +2$ ; for N,  $5 - 6 - 2 = -3$ . The net charge for the molecule is 0, as it should be since HCN is not an ion.

In the following example, to find the oxidation state of each atom in  $C_3H_7NO$  (acetone oxime) we draw boxes around each atom and the electrons it is considered to own.

For  $C_3H_7NO$  atoms the electronegativity trend is:  $H < C < N < O$ .

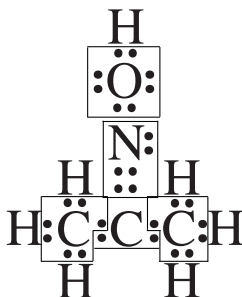

For each H,  $1 - 0 = +1$ ; for each of the two terminal C,  $4 - 7 = -3$ ; for the central C,  $4 - 2 = +2$ ; for the N,  $5 - 4 - 2 = -1$ ; for the O,  $6 - 4 - 4 = -2$ . The net charge for the molecule is 0, as it should be since  $C_3H_7NO$  is not an ion.

Note that the central C shares bonding electrons with the two terminal C atoms, since all C atoms have the same electronegativity and share the same tendency to hold on to electrons.

Formal charges on atoms are used as an aid for drawing correct Lewis structures. Oxidation states are not used.

**Formal charges** of atoms in a compound presume that electrons between atoms are being equally shared. An atom, will therefore, “own” its nonbonding electrons and one half of all its bonding electrons. Use the following formula to find formal charges. Formal charge = Valence Electrons – Nonbonding Electrons –  $\frac{1}{2}$  Bonding Electrons.

Let’s look again at HCN. This time boxes will outline nonbonding electrons and  $\frac{1}{2}$  of the bonding electrons of each atom.



For H,  $1 - 1 = 0$ ; for C,  $4 - 4 = 0$ ; for N,  $5 - 5 = 0$ . There are no atoms with a formal charge which means we have drawn the correct Lewis structure.

When calculating formal charges, the following situations will indicate that the structure you have drawn may be incorrect.

- 1) Atoms with large charges; charges greater than +2 or - 2.
- 2) Positive charges on highly electronegative elements, or negative charges on elements which are not very electronegative.

Here is an example of finding the correct Lewis structure of a positively charged ion:  $\text{NH}_4^{1+}$  (the ammonium ion). First we write the symbols for the elements and put dashes between them. Next we count valence electrons and subtract the number of electrons used as bonds.

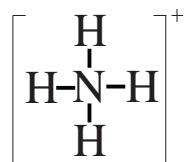

$$\begin{array}{rcl} 1 \text{ N} \times 5e & = & 5 e^- & - 1 e^- \text{ (subtract } 1e^- \text{ for } + \text{ charge on ion)} \\ 4 \text{ H} \times 1e & = & 4 e^- & - 8 e^- \text{ (4 bonds} \times 2 e^- \text{ used/bond)} \\ \hline \text{Total valence electrons} & & 9 e^- & 9 e^- \text{ used} \end{array}$$

9  $e^-$  available, 9 used. Now determine formal charges.

For each H,  $1 - 1 = 0$ ; for the N  $5 - 4 = +1$ . The formal charge on the N matches the charge on the ion, so the structure is correct.

The next example illustrates how to draw structures containing elements from the 3rd period and beyond (i.e. periods 4, 5, ...). Recall that these atoms have empty *d* subshells that can accept bonding electrons.

$\text{H}_2\text{SO}_4$ , sulfuric acid, is one of the most important chemicals produced worldwide. First we write the symbols for the elements and put dashes between them.

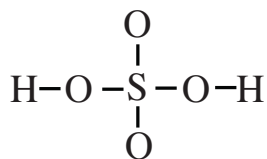

Next we count valence electrons and subtract the number of electrons used as bonds.

$$\begin{array}{rcl} 1 \text{ S} \times 6 e & = & 6 e^- & 32 e^- \text{ (total valence electrons)} \\ 4 \text{ O} \times 6e & = & 24 e^- & - 12 e^- \text{ (6 bonds} \times 2 e \text{ used/bond)} \\ 2 \text{ H} \times 1e & = & 2 e^- & 20 e^- \text{ to distribute} \\ \hline \text{Total valence electrons} & & 32 e^- & \end{array}$$

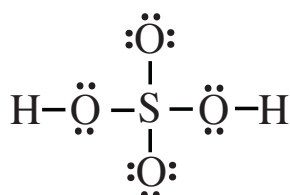

The two H have two electrons each for a duet. Each O has an octet, as does S. It appears that we are finished, but we didn't calculate the formal charges yet. We can do that now, and this is what we find...

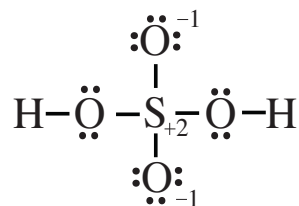

We have formal charges which sum to zero, and that is good. However, we would like to see no charges if possible, and it is possible because the central atom is S, and it is found in period 3. We move lone pairs of electrons from the oxygen atoms into their bonds with sulfur. Each O loses a negative charge, and the S has its +2 charge cancelled.

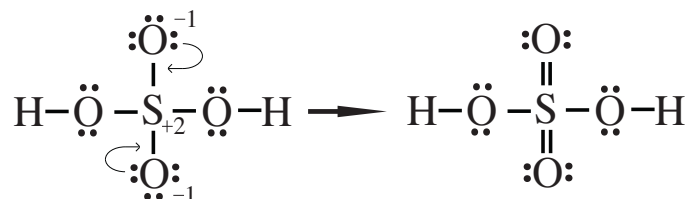

The S atom now has 12 electrons surrounding it, but that is acceptable because S is able to use empty *d* orbitals to accommodate the electrons.

Below are five different Lewis structures for CO<sub>2</sub> (carbon dioxide). Which is the best one (most likely to exist)?

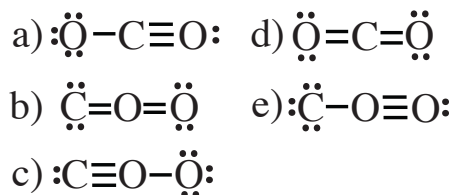

The following is another problem in picking the best Lewis structure for a molecule. In this case, we look at N<sub>2</sub>O, nitrous oxide, or laughing gas, used in dentistry.

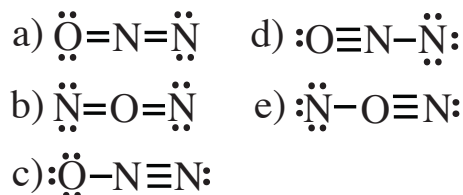

There is one more molecular strategy that can overcome the problem of formal charges. It is the chemical equivalent of a mule, and it is called resonance.



## 6. Resonance.

$\text{NO}_3^-$ , the nitrate ion, will be used to illustrate resonance.

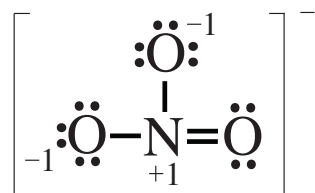

Each atom has an octet, and one of the negative charges matches the ionic charge, while the other negative charge cancels the positive charge on the N atom. There is not a way to get rid of the positive charge and one of the negative charges. If the negative charge can be shared among the three oxygen atoms, the energy expense of holding the charge can be lowered. The sharing is called resonance, and the Lewis structures below give an imaginary picture of how it takes place. (Chemists use the double pointed arrows for resonance only. These are not ordinary chemical reactions).

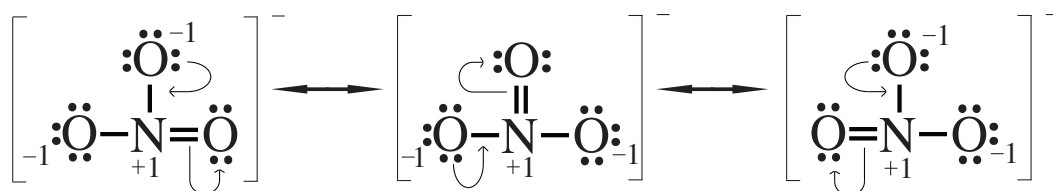

These are not actual changes. The three forms of the nitrate ion do not switch back and forth with each other, but it is difficult to make drawings that reflect the true situation. In reality, the three forms blend together to form one structure, a hybrid.

Consider a similar blending of characteristics in the biological world. The mating of a horse with a donkey produces a hybrid we call a mule. A mule is not a horse at one moment in time and a donkey at another. A mule has characteristics of both parents at all times.

Resonance hybrids present a similar situation chemically. How do chemists know that resonance hybrids exist as one blended structure? Measurements of the lengths of the bonds between the O atoms and the central N atom indicate that each bond is shorter than a single bond but longer than a double bond, and each bond is exactly like the other two. Below is the best Lewis structure that can be made for a hybrid molecule or ion. The dotted lines are partial bonds, and the three negative charges of  $(-2/3) + (-2/3) + (-2/3)$  add up to  $-2$ . The  $+1$  charge on N cancels  $-1$ , leaving a charge of  $-1$  on the ion.

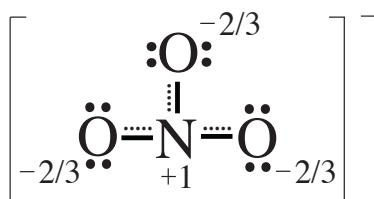

## LAB PROCEDURES

### 1. PART I: Inorganic molecules and ions.

In PART I, first draw the Lewis structures of some simple inorganic substances in the blanks provided. Then make a model of the substance, and show it to your teacher.

<u>Formula and Name</u>	<u>Draw the Lewis Structure</u>	<u>Model Checked by Teacher</u>
H <sub>2</sub> (hydrogen gas)	_____	_____
Cl <sub>2</sub> (chlorine gas)	_____	_____
CO <sub>2</sub> (carbon dioxide gas)	_____	_____
NH <sub>4</sub> <sup>1+</sup> (ammonium ion)	_____	_____
NO <sub>3</sub> <sup>1-</sup> (nitrate ion)	_____	_____
PF <sub>5</sub> (phosphorus pentafluoride)	_____	_____
SF <sub>4</sub> (sulfur tetrafluoride)	_____	_____
SO <sub>3</sub> (sulfur trioxide)	_____	_____
SF <sub>5</sub> <sup>-</sup> (sulfur pentafluoride ion)	_____	_____
PF <sub>4</sub> <sup>-</sup> (phosphorus tetrafluoride ion)	_____	_____

## 2. PART II: Constructing Models of Organic Substances.

Organic compounds contain carbon; however, some like  $\text{CO}_2$ ,  $\text{CO}$ ,  $\text{H}_2\text{CO}_3$  are not considered to be organic. Other elements frequently occurring with carbon are hydrogen, oxygen, nitrogen, and sulfur. Many organic compounds also contain phosphorus, halogens, and metals as well.

Using Lewis structures as guides, first construct models of some hydrocarbons, that is substances composed only of carbon and hydrogen. Next make organic models that contain oxygen followed by organic compounds with nitrogen.

### 2.1 Alkanes

Alkanes are saturated hydrocarbons. That is they only have single bonds between carbons, and they will not accept additional hydrogen atoms.

#### Compound and Lewis Structure

Methane

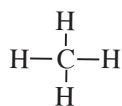

Isobutane

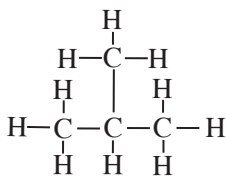

#### Compound and Lewis Structure

Propane

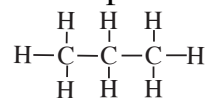

Cyclopentane (a ring compound)

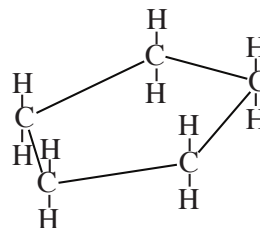

### 2.2 Alkenes

Alkenes are unsaturated hydrocarbons. These compounds have at least one double bond between any two neighboring carbon atoms.

#### Compound and Lewis Structure

Ethylene (ethene)

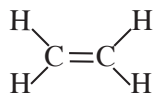

### 2.3 Alkynes

Alkynes are also unsaturated hydrocarbons, but they have at least one triple bond in the molecule.

#### Compound and Lewis Structure

Acetylene (ethyne)



## 2.4 Aromatic Organic Compounds

Aromatic organic compounds are a special category of unsaturated hydrocarbons. A common example is benzene.

### Compound and Lewis Structure

Benzene (use 6 black, 3-peg atoms for this molecule)

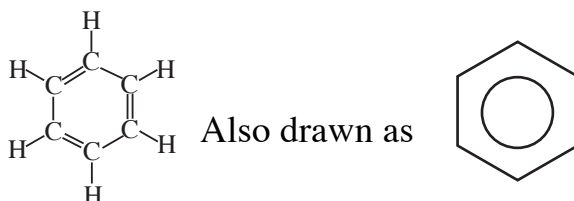

## 2.5 Organic Compounds with Oxygen

Now we can add oxygen atoms to carbon skeletons to make an alcohol, a ketone, an aldehyde, an acid, an ester, and an ether.

### Compound and Lewis Structure

Ethanol (ethyl alcohol)

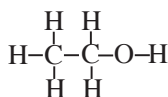

Formaldehyde (methanal)

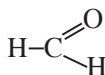

Ethyl acetate

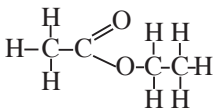

### Compound and Lewis Structure

Acetone (propanone)

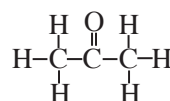

Acetic (ethanoic) acid

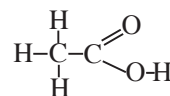

Dimethyl ether

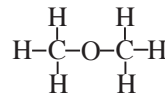

## 3. PART III Constructing models of biochemical substances.

Like other organic compounds, biochemicals exist in a dazzling number and variety. We will examine but a few examples here.

### Compound and Lewis Structure

Urea (a metabolic waste product)



### Compound and Lewis Structure

Deoxyribose (the sugar in DNA)

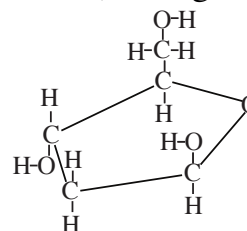

## Compound and Lewis Structure

Tyrosine (an amino acid)

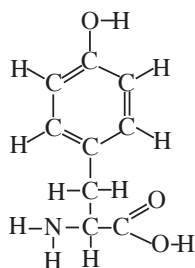

Acetyl salicylic acid (aspirin)

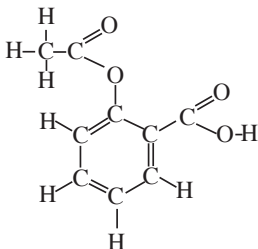

## Compound and Lewis Structure

Serotonin (a chemical messenger in the brain)

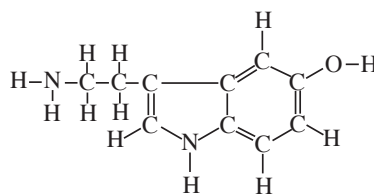

Ascorbic acid (vitamin C)

